

GA200TS60U

"HALF-BRIDGE" IGBT INT-A-PAK

Ultra-Fast™ Speed IGBT

Features

- Generation 4 IGBT technology
- UltraFast: Optimized for high operating frequencies 8-40 kHz in hard switching, >200 kHz in resonant mode
- Very low conduction and switching losses
- HEXFRED™ antiparallel diodes with ultra- soft recovery
- Industry standard package
- UL approved

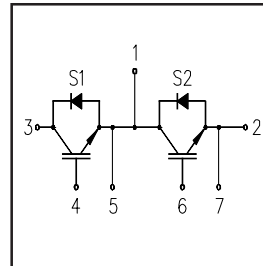

$V_{CES} = 600V$
$V_{CE(on) typ.} = 1.8V$
@ $V_{GE} = 15V, I_C = 200A$

Benefits

- Increased operating efficiency
- Direct mounting to heatsink
- Performance optimized for power conversion: UPS, SMPS, Welding
- Lower EMI, requires less snubbing

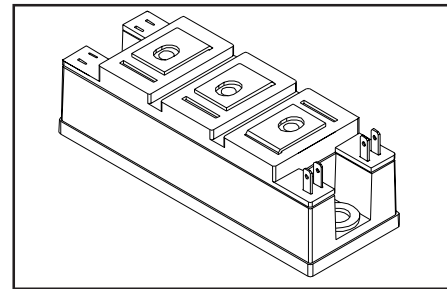

Absolute Maximum Ratings

	Parameter	Max.	Units
V_{CES}	Collector-to-Emitter Voltage	600	V
$I_C @ T_C = 25^\circ C$	Continuous Collector Current	200	A
I_{CM}	Pulsed Collector Current ^①	400	
I_{LM}	Peak Switching Current ^②	400	
I_{FM}	Peak Diode Forward Current	400	
V_{GE}	Gate-to-Emitter Voltage	± 20	V
V_{ISOL}	RMS Isolation Voltage, Any Terminal To Case, $t = 1 \text{ min}$	2500	
$P_D @ T_C = 25^\circ C$	Maximum Power Dissipation	625	W
$P_D @ T_C = 85^\circ C$	Maximum Power Dissipation	325	
T_J	Operating Junction Temperature Range	-40 to +150	$^\circ C$
T_{STG}	Storage Temperature Range	-40 to +125	

Thermal / Mechanical Characteristics

	Parameter	Typ.	Max.	Units
$R_{\theta JC}$	Thermal Resistance, Junction-to-Case - IGBT	—	0.20	$^\circ C/W$
$R_{\theta JC}$	Thermal Resistance, Junction-to-Case - Diode	—	0.35	
$R_{\theta CS}$	Thermal Resistance, Case-to-Sink - Module	0.1	—	
	Mounting Torque, Case-to-Heatsink ^③	—	6.0	N·m
	Mounting Torque, Case-to-Terminal 1, 2 & 3 ^④	—	5.0	
	Weight of Module	200	—	g

Electrical Characteristics @ T_J = 25°C (unless otherwise specified)

	Parameter	Min.	Typ.	Max.	Units	Conditions
V _{(BR)CES}	Collector-to-Emitter Breakdown Voltage	600	—	—	V	V _{GE} = 0V, I _C = 1mA
V _{CE(on)}	Collector-to-Emitter Voltage	—	1.8	2.2		V _{GE} = 15V, I _C = 200A
		—	1.9	—		V _{GE} = 15V, I _C = 200A, T _J = 125°C
V _{GE(th)}	Gate Threshold Voltage	3.0	—	6.0		I _C = 1.25mA
ΔV _{GE(th)/ΔT_J}	Temperature Coeff. of Threshold Voltage	—	-11	—	mV/°C	V _{CE} = V _{GE} , I _C = 1.25mA
g _{fe}	Forward Transconductance ④	—	175	—	S	V _{CE} = 25V, I _C = 200A
I _{CES}	Collector-to-Emitter Leaking Current	—	—	1.0	mA	V _{GE} = 0V, V _{CE} = 600V
		—	—	10		V _{GE} = 0V, V _{CE} = 600V, T _J = 125°C
V _{FM}	Diode Forward Voltage - Maximum	—	3.7	—	V	I _F = 200A, V _{GE} = 0V
		—	3.7	—		I _F = 200A, V _{GE} = 0V, T _J = 125°C
I _{GES}	Gate-to-Emitter Leakage Current	—	—	250	nA	V _{GE} = ±20V

Dynamic Characteristics - T_J = 125°C (unless otherwise specified)

	Parameter	Min.	Typ.	Max.	Units	Conditions
Q _g	Total Gate Charge (turn-on)	—	903	1355	nC	V _{CC} = 400V, V _{GE} = 15V
Q _{ge}	Gate - Emitter Charge (turn-on)	—	125	188		I _C = 135A
Q _{gc}	Gate - Collector Charge (turn-on)	—	306	459		T _J = 25°C
t _{d(on)}	Turn-On Delay Time	—	342	—	ns	R _{G1} = 27Ω, R _{G2} = 0Ω,
t _r	Rise Time	—	194	—		I _C = 200A
t _{d(off)}	Turn-Off Delay Time	—	366	—		V _{CC} = 360V
t _f	Fall Time	—	213	—		V _{GE} = ±15V
E _{on}	Turn-On Switching Energy	—	12	—	mJ	
E _{off(1)}	Turn-Off Switching Energy	—	16	—		
E _{ts(1)}	Total Switching Energy	—	28	39		
C _{ies}	Input Capacitance	—	20068	—	pF	V _{GE} = 0V
C _{oes}	Output Capacitance	—	1254	—		V _{CC} = 30V
C _{res}	Reverse Transfer Capacitance	—	261	—		f = 1 MHz
t _{rr}	Diode Reverse Recovery Time	—	179	—	ns	I _C = 200A
I _{rr}	Diode Peak Reverse Current	—	120	—		A
Q _{rr}	Diode Recovery Charge	—	10714	—	μC	R _{G2} = 0Ω
di _(rec) /dt	Diode Peak Rate of Fall of Recovery During t _b	—	1922	—	A/μs	V _{CC} = 360V di/dt = 1300A/μs

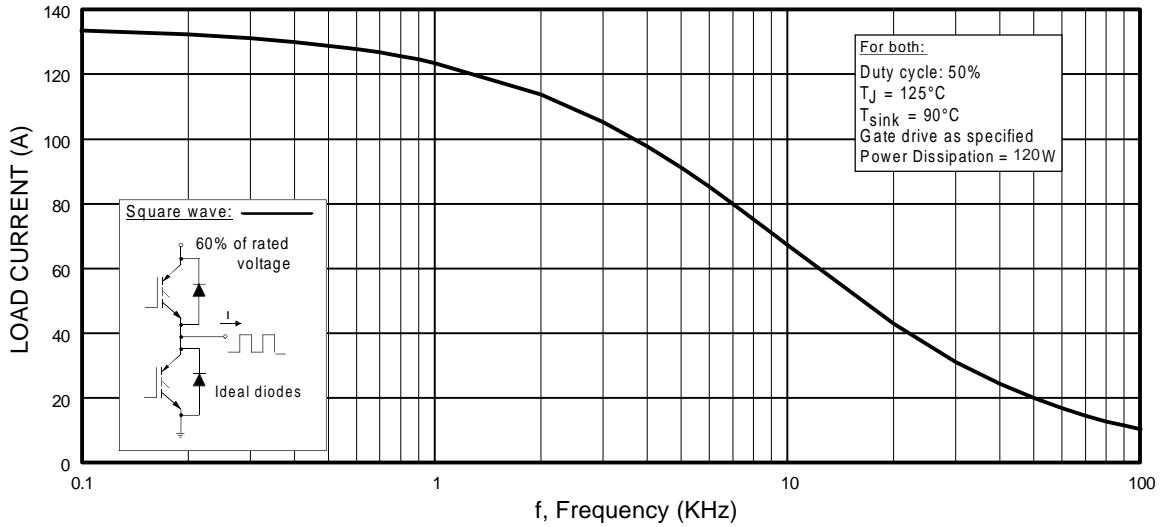

Fig. 1 - Typical Load Current vs. Frequency
 (Load Current = I_{RMS} of fundamental)

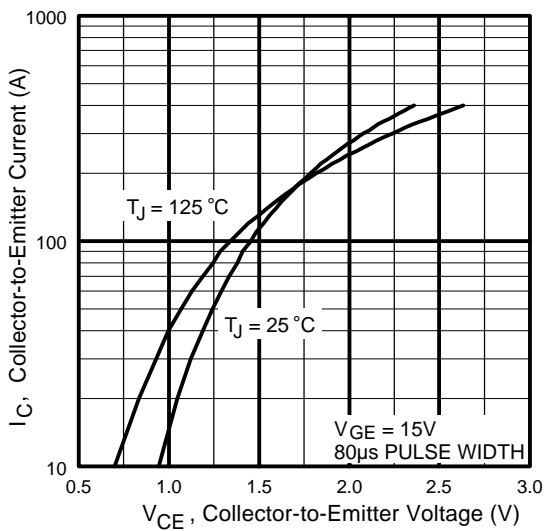

Fig. 2 - Typical Output Characteristics

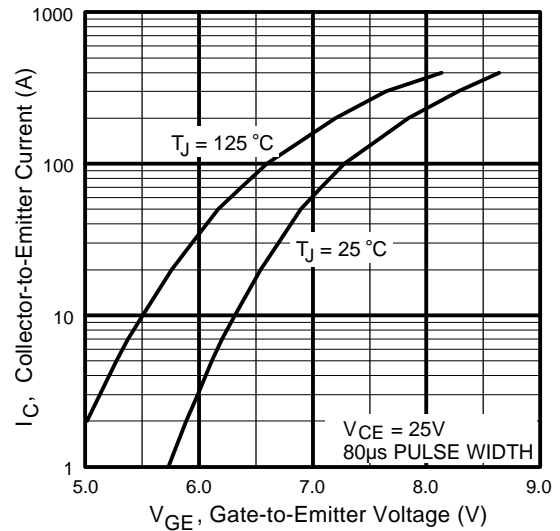

Fig. 3 - Typical Transfer Characteristics

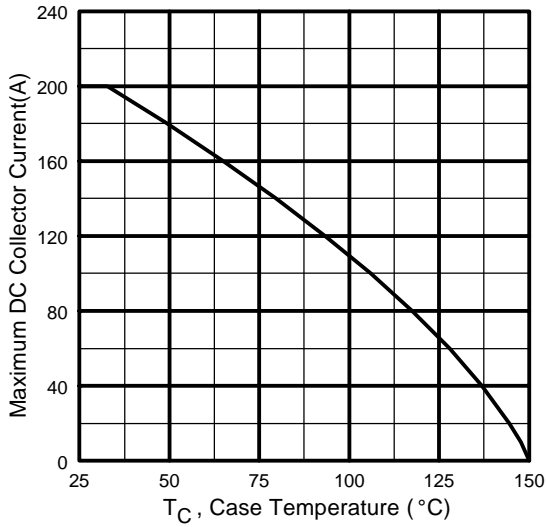

Fig. 4 - Maximum Collector Current vs. Case Temperature

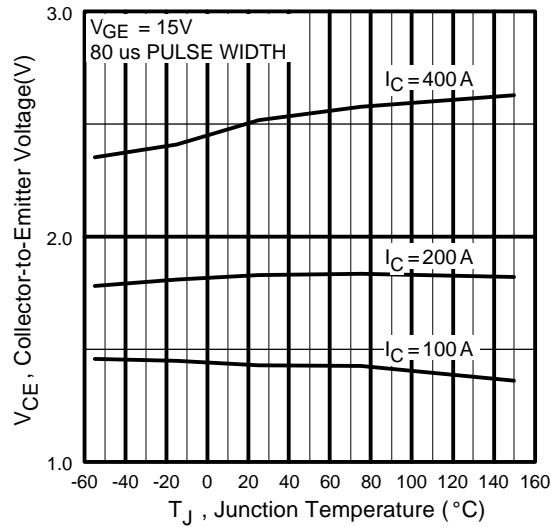

Fig. 5 - Typical Collector-to-Emitter Voltage vs. Junction Temperature

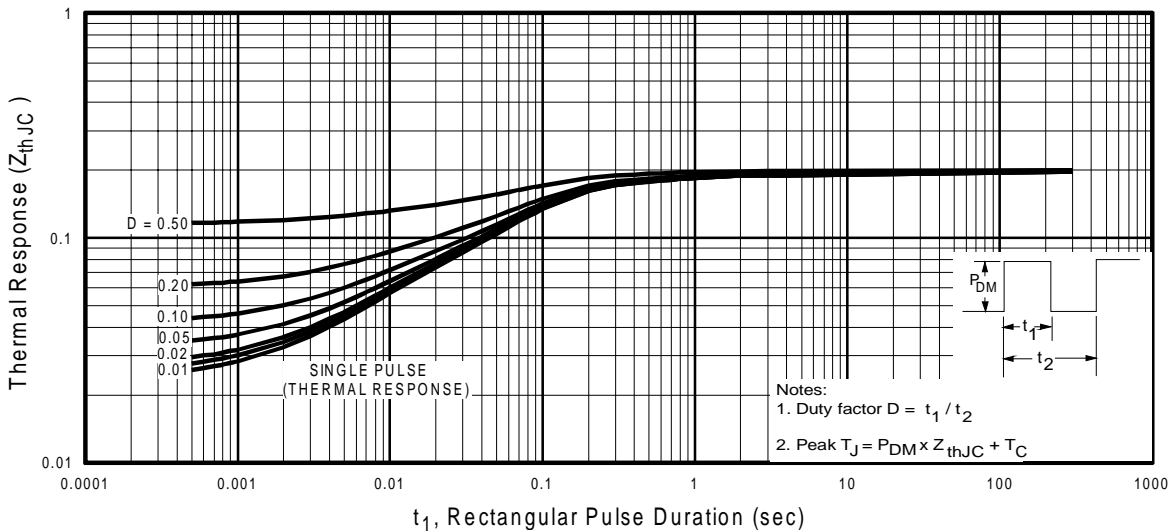

Fig. 6 - Maximum Effective Transient Thermal Impedance, Junction-to-Case

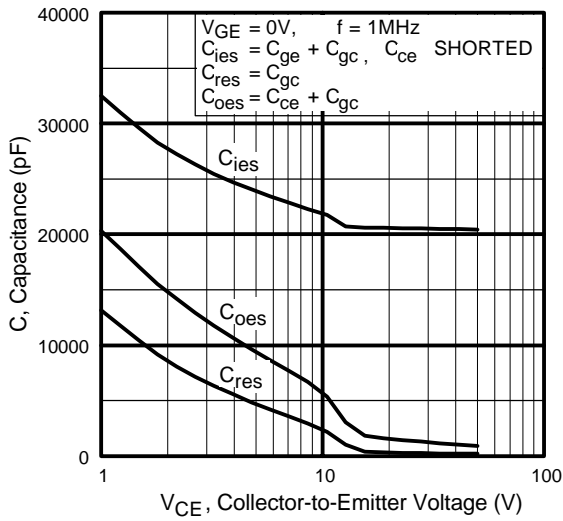

Fig. 7 - Typical Capacitance vs. Collector-to-Emitter Voltage

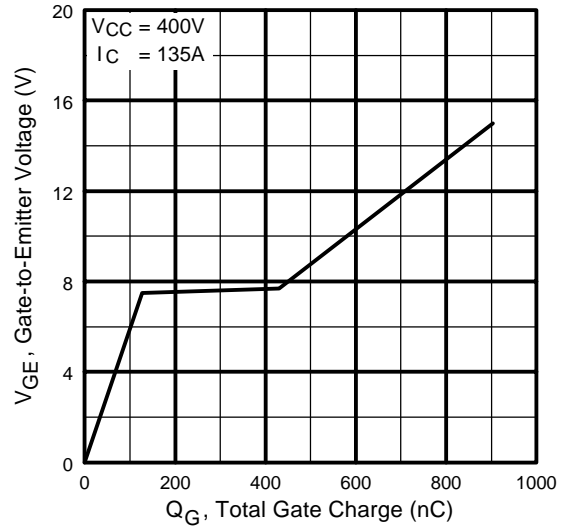

Fig. 8 - Typical Gate Charge vs. Gate-to-Emitter Voltage

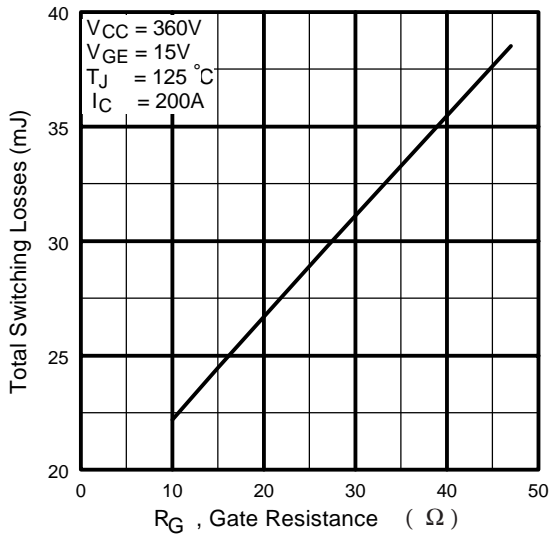

Fig. 9 - Typical Switching Losses vs. Gate Resistance

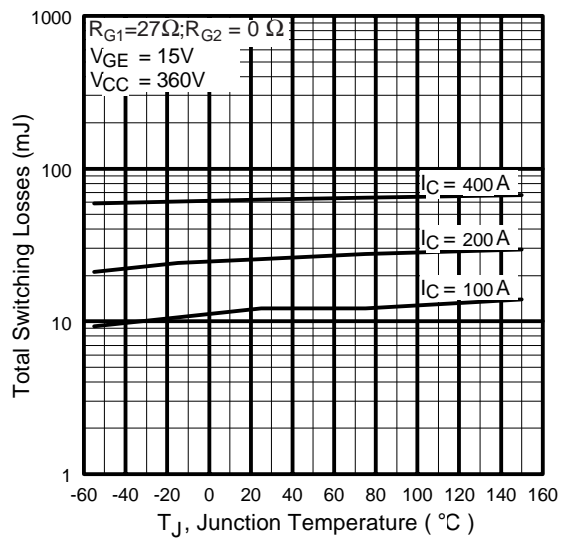

Fig. 10 - Typical Switching Losses vs. Junction Temperature

GA200TS60U

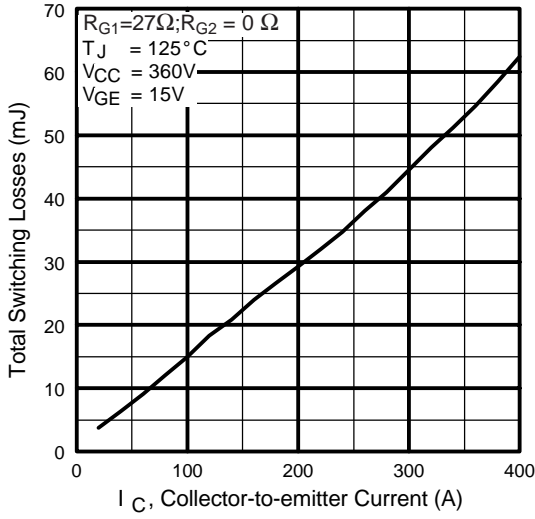

Fig. 11 - Typical Switching Losses vs. Collector-to-Emitter Current

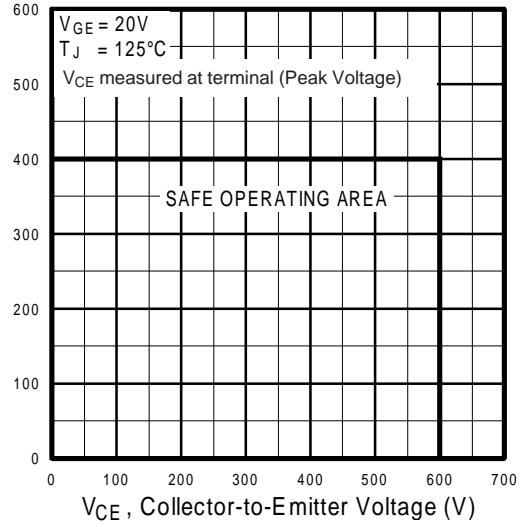

Fig. 12 - Reverse Bias SOA

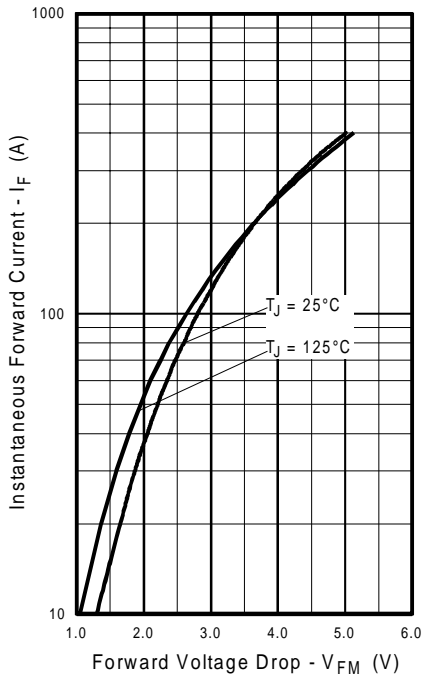

Fig. 13 - Typical Forward Voltage Drop vs. Instantaneous Forward Current

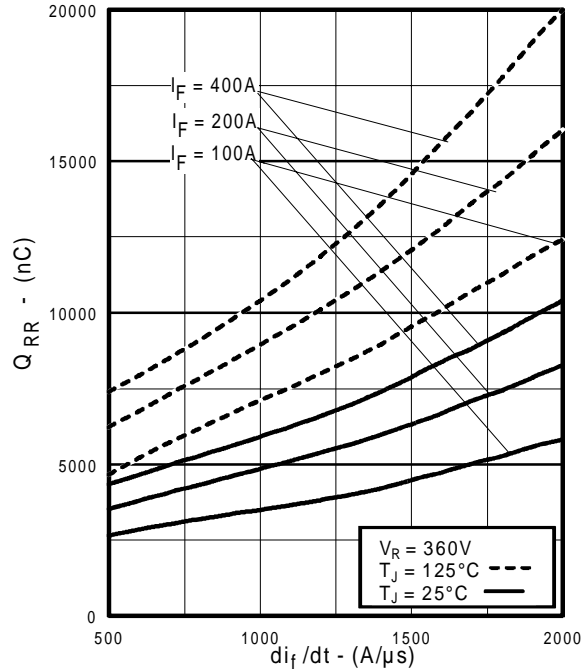

Fig. 14 - Typical Stored Charge vs. di_f/dt

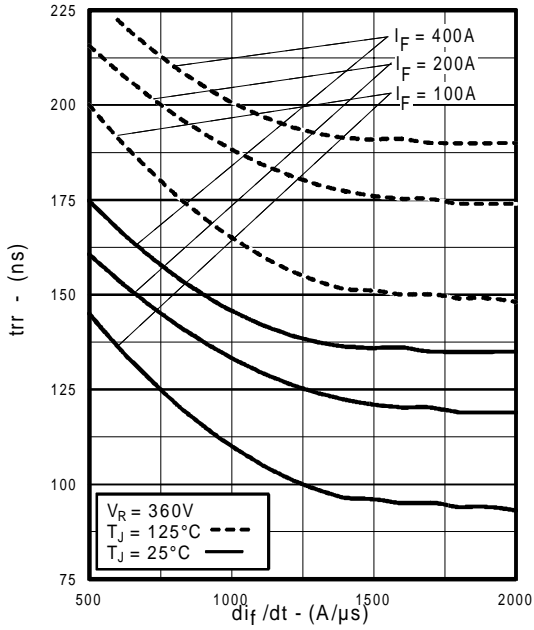

Fig. 15 - Typical Reverse Recovery vs. di_f/dt

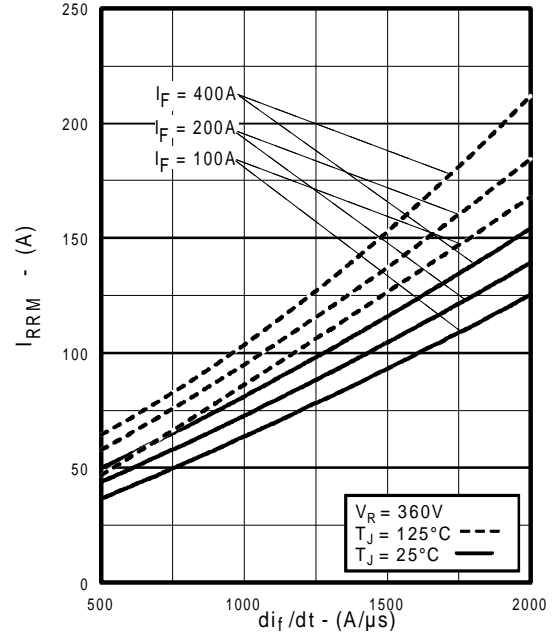

Fig. 16 - Typical Recovery Current vs. di_f/dt

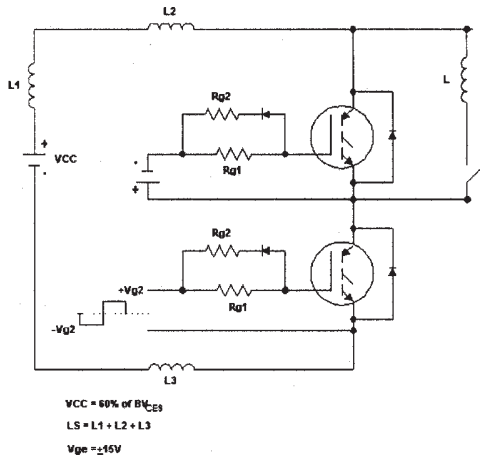

Fig. 17a - Test Circuit for Measurement of I_{LM} , E_{on} , $E_{off}(\text{diode})$, t_{rr} , Q_{rr} , I_{rr} , $t_{d(on)}$, t_r , $t_{d(off)}$, t_f

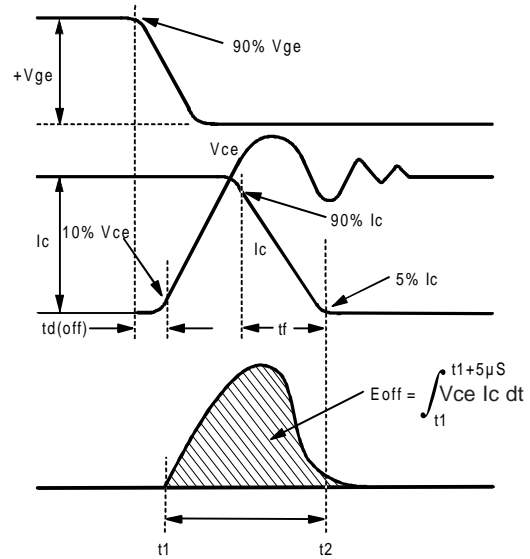

Fig. 17b - Test Waveforms for Circuit of Fig. 18a, Defining E_{off} , $t_{d(off)}$, t_f

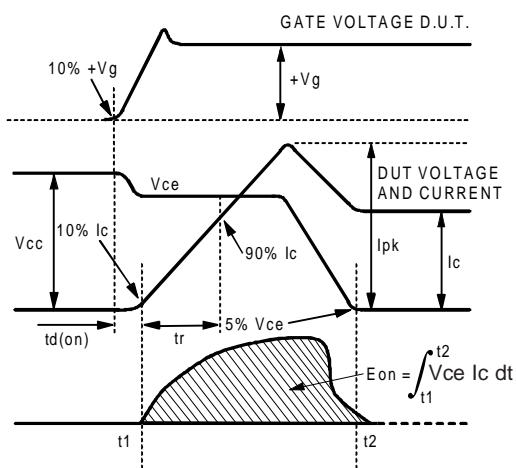

Fig. 17c - Test Waveforms for Circuit of Fig. 18a, Defining E_{on} , $t_{d(on)}$, t_r

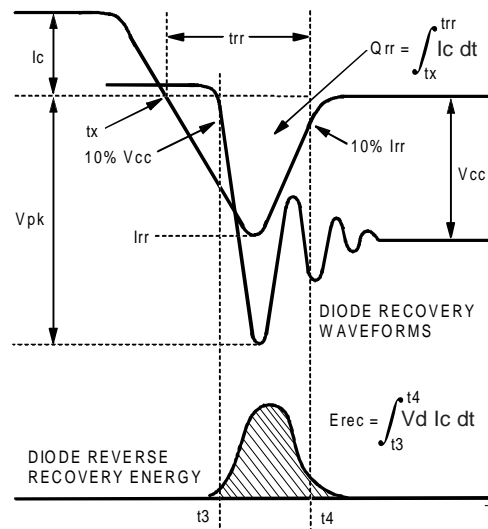

Fig. 17d - Test Waveforms for Circuit of Fig. 18a, Defining E_{rec} , t_{rr} , Q_{rr} , I_{rr}

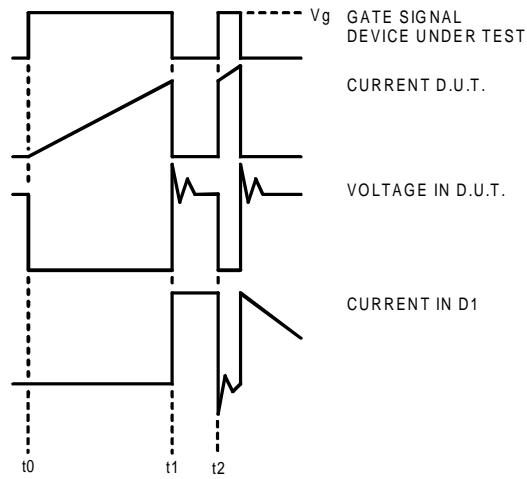

Figure 17e. Macro Waveforms for Figure 18a's Test Circuit

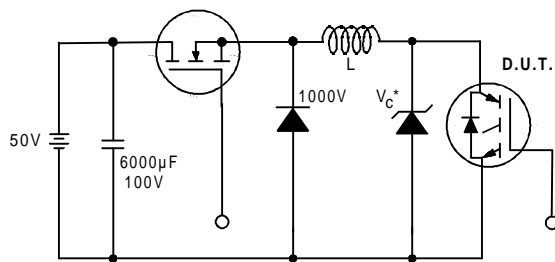

Figure 18. Clamped Inductive Load Test Circuit

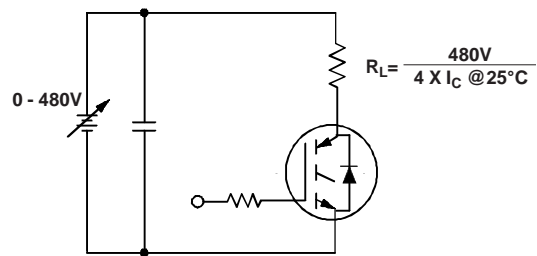

Figure 19. Pulsed Collector Current Test Circuit

GA200TS60U

International
IR Rectifier

Notes:

- ① Repetitive rating; $V_{GE} = 20V$, pulse width limited by max. junction temperature.
- ② See fig. 17
- ③ For screws M6.
- ④ For screws M5.
- ⑤ Pulse width 50 μ s; single shot.

Case Outline — INT-A-PAK

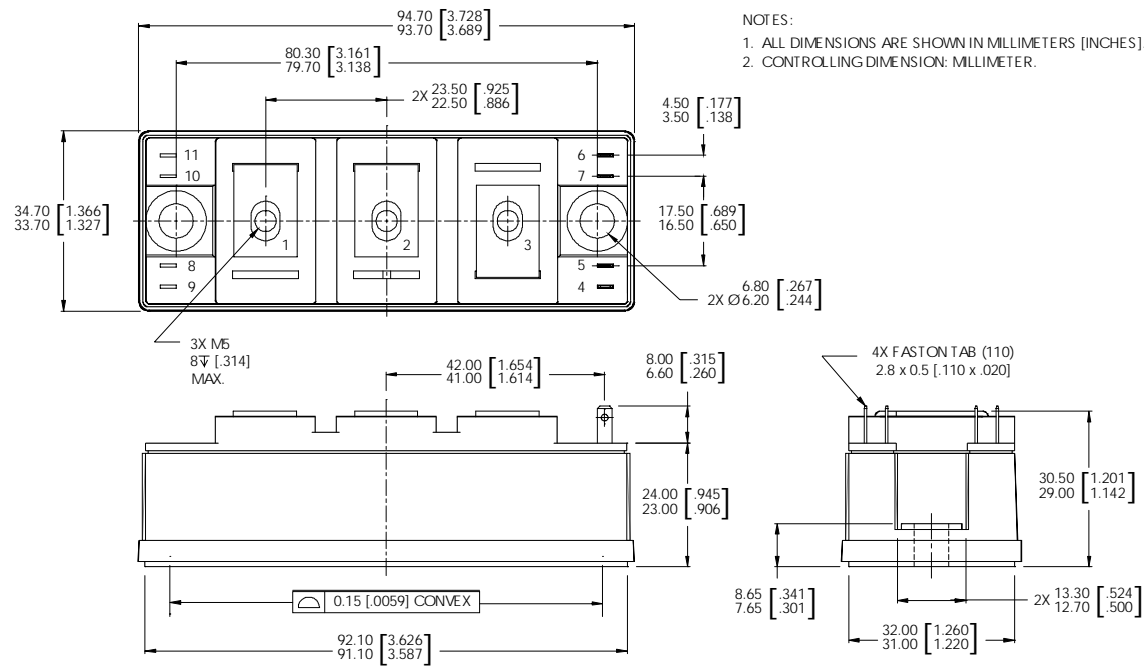

Data and specifications subject to change without notice.
This product has been designed and qualified for the Industrial market.
Qualification Standards can be found on IR's Web site.

International
IR Rectifier

IR WORLD HEADQUARTERS: 233 Kansas St., El Segundo, California 90245, USA Tel: (310) 252-7105
TAC Fax: (310) 252-7903
Visit us at www.irf.com for sales contact information.05/02